

DSPM

High Precision
Measurements

Products catalog

DSPM **Industria**[®]
sensori & trasduttori

Via Paolo Uccello 4 - 20148 Milano
Tel +39 02 48 009 757 Fax +39 02 48 002 070
info@dspmindustria.it www.dspmindustria.it

Table of contents



General information

High Precision Measurements	5
How it works	6
Why HPM	8

Wire strain gages

General information	10
STN series high-temperature strain gages	11
STP series high-temperature strain gages	12
STF series high-temperature strain gages	13
Wire rosettes	14

Foil strain gages

High-temperature foil strain gages	17
Mid-temperature BQ250 and BAB350 foil strain gages	19

Weldable strain gages

HKB series weldable strain gages for mid-temperature	24
WTN series weldable strain gages for high-temperature	27

HPM technology for 400°C

HPM technology for 400°C strain measurement	30
---	----

Adhesives

Adhesives	32
Main adhesives characteristics	33
H-600	34
H-611	35
H-613	35
H-619	36
H-621	36
F-601	37
F-614	37
CC-02 High-temperature cement glue	38
Surface preparation agents	39



Additional tools and materials

Consumables and installation kits	41
Thermal indication paint	42
Thermocouple cable HRTW-CA	43

Special equipment

Temperature regulated curing furnace TRCF	45
CDWT-6001 capacitive discharge welding tool	47
Tool for reproducing of deformations at high temperatures HTDR-1001	48
Tuning fork calibration device TFGD-4001	50

Services

Services	52
----------------	----

Use cases

Use cases for High temperature strain gages	54
---	----



HPM

01

General
information





High Precision Measurements

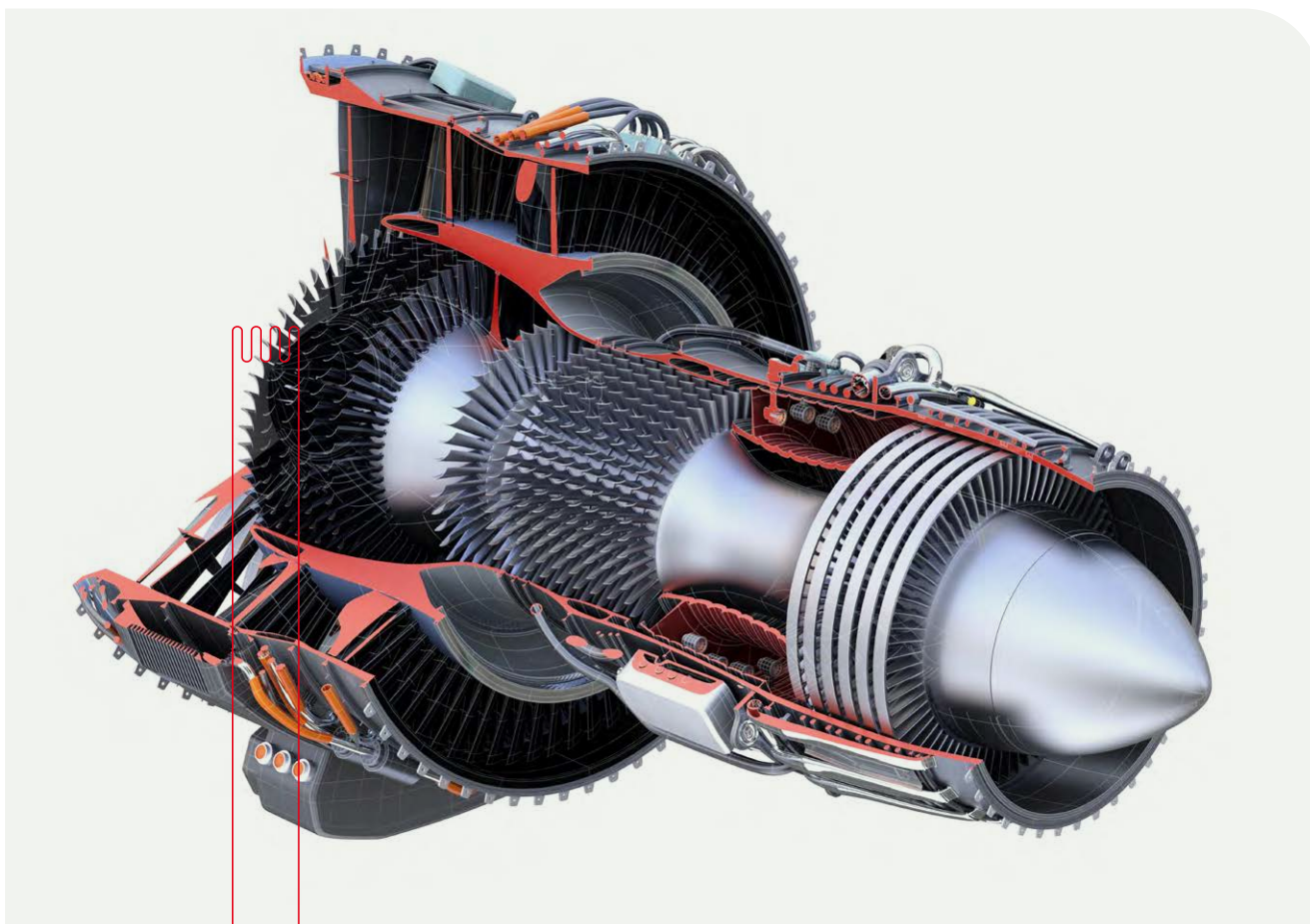

High Precision Measurements is a Ukrainian developer, producer and supplier of the specialized strain gages and accessories intended for tensile strength measurements at elevated and high temperature conditions since 2012. Our company produces wire strain gages for $-269...+1150^{\circ}\text{C}$ operating temperature range. Engineering team of our company comprises specialists in metrology, strength of materials and mechanical values measuring units. The core of our engineering team are specialists having years of practical experience of measurements and field tests at Motor-Sich factory. This particular experience helps us understand the acute needs of our customers. The motto of our company is our employees' sincere interest in scientific research and engineering, desire for constant perfection of our products.

High Precision Measurements for many years has been an official representative of ZEMIC company for strain gages and accessories for measurements at elevated temperatures. Over these years we developed many special solutions for our customers, which allow to increase speed and comfort of the strain gage application and also increase precision of measurements.



How it works

Measurement of stress-strain parameters of machine parts is the most important task in ensuring their strength and reliability. To measure the deformation of parts, strain gages – resistors whose resistance changes depending on its deformation (stretching or compression) – are widely used. Strain gages are used both for measuring the deformation of various parts for research and testing purposes and as part of various sensors: force or weight, pressure, displacement, torque.

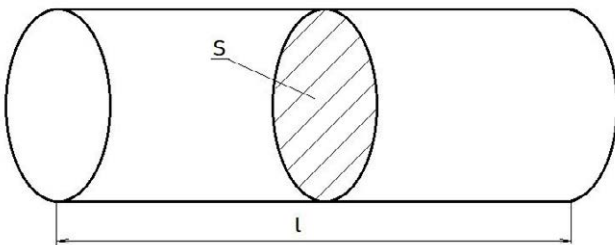

The phenomenon of strain sensitivity of any conductor follows from the well-known conductor resistance formula:

$$R = \rho \frac{l}{S}$$

where ρ – specific resistivity of conductor material, l – conductor length, S – cross-sectional area of the conductor.

It can be seen that the resistance is proportional to the length of the conductor: if the conductor is stretched or compressed, its resistance will increase or decrease accordingly. It is also known that if a body is stretched, its cross-section decreases (which will cause an even greater increase in resistance), and vice versa, if a body is compressed, its cross-section increases (which will cause an even greater decrease in resistance). In addition, not only the geometry of the conductor can change under the action of deformation, but also the resistivity.

The strain sensitivity of a strain gage, known as gage factor, is the ratio between the relative change in its resistance under strain and the magnitude of the relative strain:

$$k = \frac{\Delta R/R}{(\Delta l/l)}$$

Due to the combination of stretching/compression and reduction/increase in conductor cross-

section, for most metals and alloys the gage factor is close to two. However, some metals and alloys have abnormally high (platinum) or abnormally low (manganin) strain sensitivity coefficient. Of course, materials with the highest possible strain sensitivity are preferred for strain gages.

For the convenience of measuring strain gage parameters from the point of view of construction of measuring equipment, it is desirable that the strain gage has a sufficiently high resistance, tens to hundreds of ohms, for this purpose the length of the conductor should be sufficiently large. At the same time, in order to measure the strain in small localized areas of the parts, in the areas of highest stress, it is necessary that the size of the strain gage should be small. Therefore, the classical modern strain gage is a conductor with a "snake" (grid) configuration, made of thin foil or wire of small (10-30 microns) diameter. In addition, alloys with a high resistivity are used to manufacture strain gages.

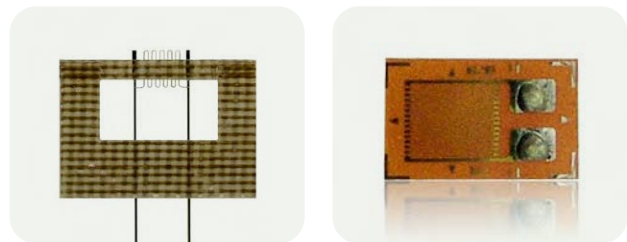

Obviously, the conductor of the strain gage must be electrically isolated from the part. For this purpose, in low-temperature strain gages, the conductor is applied to a dielectric substrate, which is subsequently glued to the part. It is clear that the substrate on the one hand electrically isolates the strain gage from the workpiece, and on the other hand it must effectively transmit strain from the workpiece to the sensitive grid of the strain gage. High-temperature free-filament strain gages do not use a substrate. For their installation, high-temperature ceramic cement is used, the first layer of which on the part provides isolation of the strain gage from the part, and subsequent layers glue the strain gage to the first layer.

To ensure high adhesion of glue or cement to the part, it is necessary to specially treat the surface: clean it from any dirt and coatings, roughen



it with sandpaper or sandblasting, treat it with special solutions.

In addition to the fact that the resistance of a conductor changes when it is deformed, it is known that the resistivity of any metal increases when heated. For strain gages, the temperature change in conductor resistance is extremely harmful. Therefore, for the manufacture of strain gages are used not pure metals, but their alloys, which have much lower temperature change in resistivity. The most widespread are such alloys as constantan, nichrome, fechral. Almost all strain gages designed for operation at low temperatures (up to 150°C) are made of constantan.

An interesting feature of constantan is that its resistivity not only varies extremely little with temperature, but is capable of not only increasing but also decreasing with heating, depending on the composition of a particular batch of the alloy, its heat treatment and the temperature value. Typical temperature characteristics of constantan resistance and some others alloys, that are used for strain gage manufacturing, are shown on the figure:

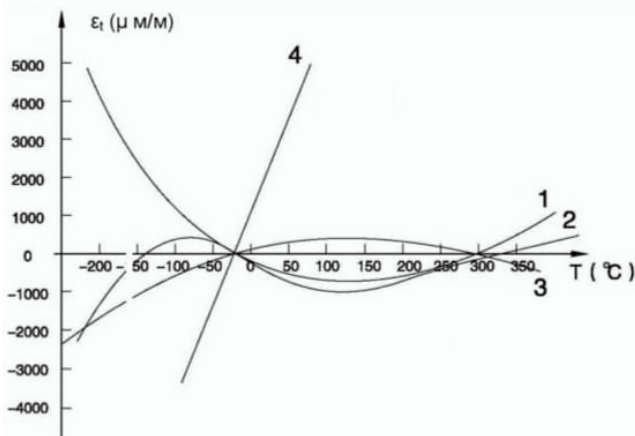

1. Constantan alloy
2. FeCrAl alloy
3. Karma alloy
4. Platinum-tungsten alloy

When a part with strain gages is heated, two processes occur simultaneously: thermal expansion of the part, causing a corresponding change in the length of the strain gage, which is glued to it, and temperature change in the resistivity of the alloy from which the sensing element is made. By selecting such alloy composition and its heat treatment (annealing) it is possible to minimize the temperature change of resistance of strain

gages when they are glued to a certain material. This is called temperature compensation of strain gages. Temperature compensated strain gages are produced for different materials:

Material	Coefficient of linear thermal expansion, 10 ⁻⁶ °C ⁻¹
Titanium	8,6
Iron, forged	11,3
Steel	13,0
Austenitic stainless steel	16,0
Aluminum	22,2
Magnesium	25,0

However, such thermocompensation "works" in a narrow temperature range (not more than ~100°C).

For more accurate compensation of the temperature effect of strain gage resistance changes on the readings of strain gage equipment in a wider temperature range, the so-called circuit compensation is used. For this purpose, two or four strain gages are glued on the part, which are in the same temperature conditions and connect them to the bridge circuit so that the effect on the output signal of the bridge due to the effect of deformation on different strain gages is summed up, and the temperature change in resistance, which is the same in all strain gages, is subtracted (compensated).

Let's consider a simple example

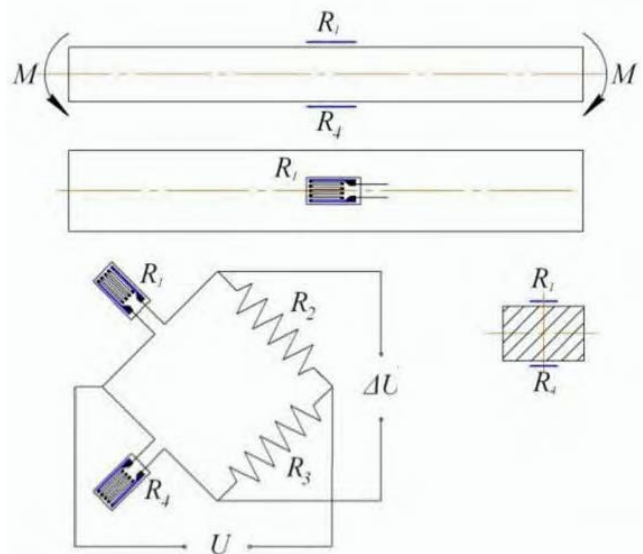



When the beam is loaded, the upper strain gage is stretched (and its resistance increases), and the lower one is compressed (and its resistance decreases). When these strain gages are connected to the different arms of the bridge, the output signal of the bridge doubles (compared to the signal when only one working strain gages are connected to the bridge). And at heating of strain gages their resistance changes equally and at inclusion of these strain gages to the bridge their "synchronous" change of resistance does not cause the appearance of a signal at the bridge output. However, in reality there is inevitable non-ideality in the coincidence of temperature conditions for each of the SGs, as well as in the coincidence of the temperature change in their resistance, and even though small, but the signal at the output of the bridge will appear.

It should be noted that at very high temperatures (from several hundred to a thousand degrees and more), the temperature "response" of strain gages is many times greater than their "response" to strain. This is not a problem when measuring dynamic strain, when the slow change of the signal due to the influence of temperature is simply "filtered out" by strain gage equipment, but measuring static strain at high temperature is a difficult technical task. A typical technique for static strain gauging at high temperature is (in addition to the mandatory use of circuit compensation) the so-called temperature calibration of the part: the part with strain gages is heated to maximum operating temperature without mechanical loading and the dependence of strain gage readings on the temperature of the part is recorded. Then, during testing, a corresponding correction is made to the measurement results.



Why HPM

HPM not only production company we are more focused on real tests, engineering and research work related to high temperature strain gauging.

Engineers prefer to work with us because of deep understanding of end users field of usage and problematics they face with. Core our team are engineers from test laboratories of Ukrainian jet engine production factory and Kyiv Polytechnic Institute so we deeply versed in strain gauging in theoretical and practical fields and able to help our partners to solve all kind problems at daily work.

At HPM, we take quality control seriously. Choose HPM with confidence, knowing that you are getting the best quality and service in the industry. We are proud to be certified to ISO9001:2015, which demonstrates our commitment to excellence. We understand that your time is valuable, that's why we always provide a prompt feedback and shorter lead time than our competitors. In addition, our extensive range of products provides you with a wide variety of options to choose from.

To summarize the reasons why engineers prefer to work with our company

- Deep understanding of customer requests and problems.
- Output control which guarantees high quality products.
- Short lead times for feedback, production and delivery.
- Lowest prices for strain gage niche products and equipment.
- The ability to produce special customized products and equipments.



HPM

02



Wire strain gages



General information

Bondable high temperature gages are intended for measurements of deformations in the details of machinery and equipment, including jet engines and gas turbines, under static and dynamic loads in -269...+1150°C temperature range.

Strain gage can be produced of NiCr, FrCrAl or PtW alloys and fixed with the temporary carrier, of fiberglass-reinforced PTFE.

Schematic drawing

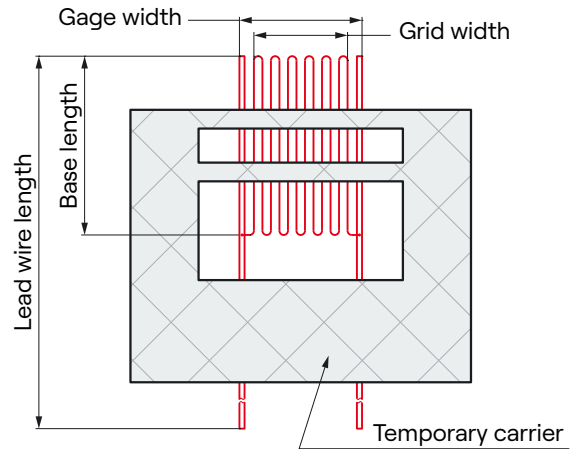

Designation system

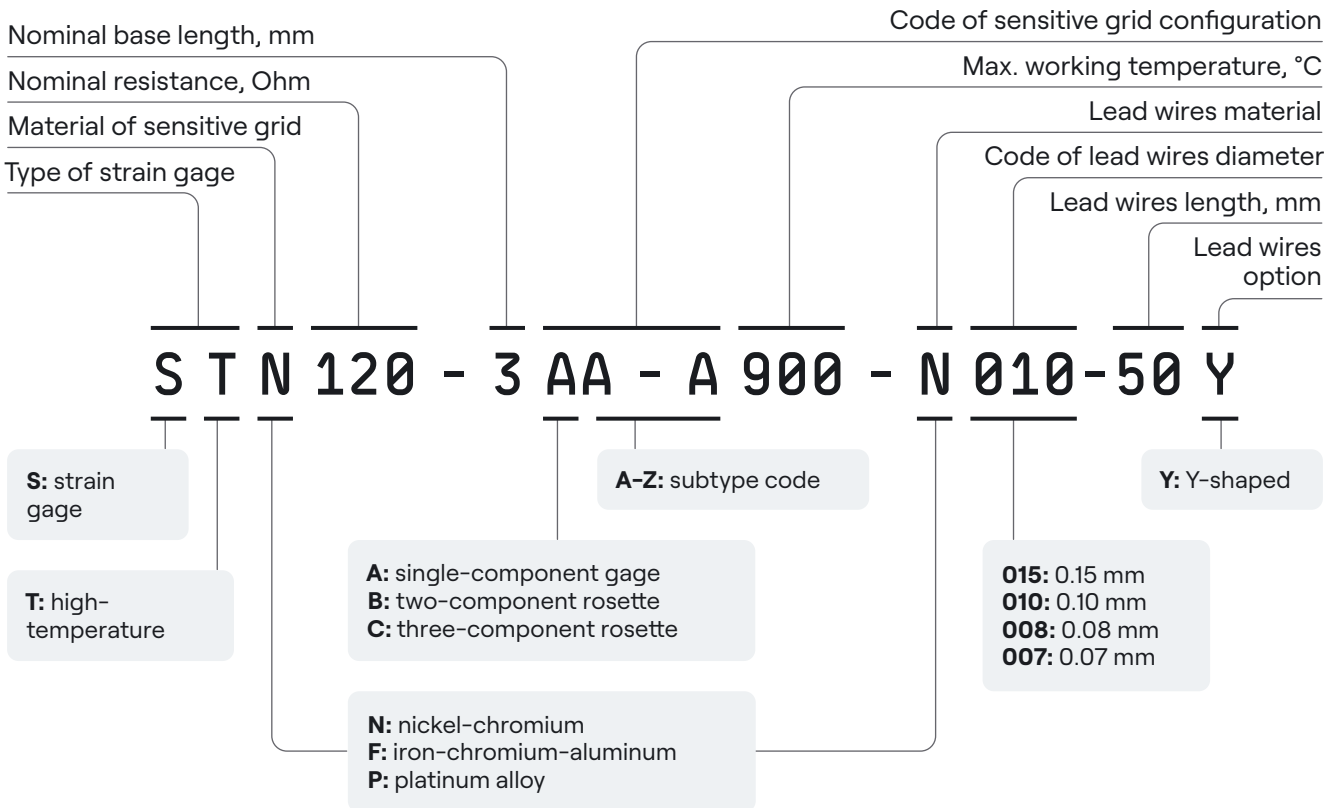

Packaging

Individual strain gages are supplied on plastic or glass carriers, can be covered with protective plastic foil. Each strain gage is labelled with the actual electric resistance values.

Groups of strain gages are packed in plastic boxes in amount of 1...25 pieces. Each group packing has a label with the main parameters of the

gages, including resistance range of the gages group, gage factor, production date, etc.

Batches of strain gages are packed in plastic containers with or without auxiliary installation tools. Each batch container has a label with all main parameters of the gages, general description, batch number and production date.

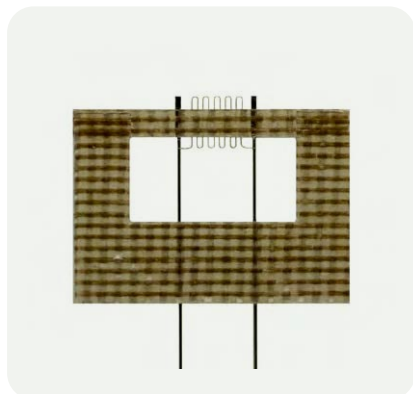

STN series high-temperature strain gages

STN strain gages are the most common type of bondable high-temperature wire strain gages for static and dynamic loads in the temperature range up to +900°C. Sensitive grid of the gage is made of 15...30 um diameter nickel-chromium alloy wire. Sensitive grid is fixed on the fiberglass-reinforced PTFE temporary backing. Lead wires are made of ribbon or round wire with 0.07...0.15 mm diameter. Material of the lead wires correlates with the sensitive grid material and also nickel-chromium based.

Specifications

Nominal parameters	Value
Sensitive grid material	Nickel-chromium
Possible number of sensitive elements	1, 2 or 3
Base length, mm	1.7-5.5
Gage width, mm	1.6-2.6
Resistance, Ohm	120-350
Resistance deviation in batch, not more than	±1% or ±3%
Lead wire material	Nickel-chromium
Lead wire diameter, mm	0.07-0.15
Lead wire type	Ribbon or round
Lead wire length, mm	50-300
Temporary carrier	Fiberglass-reinforced PTFE
Average gage factor at 20°C	2.05
Fatigue life at ±650 ppm at 20°C, cycles	10 ⁶
Bonding Methods	Ceramic Cement or Alumina flame spray
Max. working temperature	900°C
Type of measurements	Static and dynamic

Standard configurations

Strain gage configuration	Designation	Nominal resistance, Ohm	Nominal base length, mm	Nominal grid width, mm	Lead wires length, mm
	STN120-1.7AA-A900-N010-50	120	1.7	2.2	50...300*
	STN120-3AA-A900-N010-50	120	3.1	1.6	
	STN350-3.5AA-A900-N010-50	350	3.4	2.6	
	STN120-5AA-A900-N010-50	120	5.0	2.0	

*Other lead wire length can be supplied on request



STP series high-temperature strain gages

STP wire strain gages are platinum-tungsten based. They demonstrate perfect performance under dynamic loads in the temperature range up to +1150°C. Sensitive grid of these gage is made of 14...30 um diameter platinum-tungsten alloy wire. Sensitive grid is fixed on the fiberglass-reinforced PTFE temporary backing. Lead wires are made of ribbon or round wire with 0.07...0.15 mm diameter. Material of the lead wires correlates with the sensitive grid material and is also platinum alloy based.

Specifications

Nominal parameters	Value
Sensitive grid material	Platinum-tungsten
Possible number of sensitive elements	1
Base length, mm	1.6-5.5
Gage width, mm	1.6-3.2
Resistance, Ohm	120
Resistance deviation in batch, not more than	±1% or ±3%
Lead wire material	platinum-based alloy
Lead wire diameter, mm	0.07-0.15
Lead wire type	Ribbon or round
Lead wire length, mm	50-300
Temporary carrier	Fiberglass-reinforced PTFE
Average gage factor at 20°C	3.5
Fatigue life at ±650 ppm at 20°C, cycles	10 ⁶
Bonding Methods	Ceramic Cement or Alumina flame spray
Max. working temperature	1150°C
Type of measurements	Dynamic

Standard configurations

Strain gage configuration	Designation	Nominal resistance, Ohm	Nominal base length, mm	Nominal grid width, mm	Lead wires length, mm
	STP120-1.6AA-A1150-P007-45	120	1.6	3.2	
	STP120-3AA-A1150-P007-45	120	2.95	1.6	50...300*
	STP120-5AA-A1150-P007-45	120	5.5	2.0	

*Other lead wire length can be supplied on request

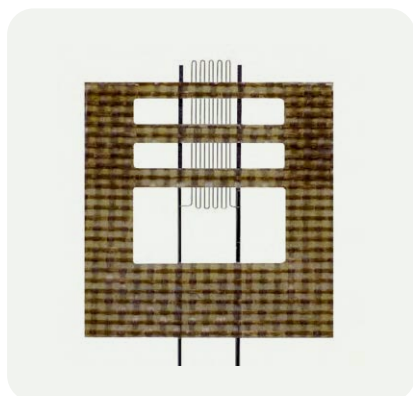

STF series high-temperature strain gages

Fe-Cr-Al alloy gages are designed for the use in the widest operating temperature range. These bondable high-temperature wire strain gages are dedicated for measurements of deformations in the details of machinery and equipment, including jet engines, under static and dynamic loads up to +1150°C temperature range. Sensitive grid of the gage is made of 15...30 μm diameter iron-chromium-aluminum alloy wire. Sensitive grid is fixed on the fiberglass-reinforced PTFE temporary backing. Lead wires are made of ribbon or round wire with 0.07...0.15 mm diameter. Material of the lead wires correlates with the sensitive grid material and is also iron-chromium-aluminum based.

Specifications

Nominal parameters	Value
Sensitive grid material	Iron-chromium-aluminum
Possible number of sensitive elements	1
Base length, mm	1.9-3.5
Gage width, mm	1.6-2.7
Resistance, Ohm	120-350
Resistance deviation in batch, not more than	±1% or ±3%
Lead wire material	Iron-chromium-aluminum
Lead wire diameter, mm	0.07-0.15
Lead wire type	Ribbon or round
Lead wire length, mm	50-300
Temporary carrier	Fiberglass-reinforced PTFE or filter paper
Average gage factor at 20°C	2.3
Fatigue life at ±650 ppm at 20°C, cycles	10 ⁶
Bonding Methods	Ceramic Cement or Alumina flame spray
Max. working temperature	1150°C
Type of measurements	Static and dynamic

Standard configurations

Strain gage configuration	Designation	Nominal resistance, Ohm	Nominal base length, mm	Nominal grid width, mm	Lead wires length, mm
	STF120-1.9AA-A1150-F015-50	120	1.9	2.3	50...300*
	STF120-2.3AA-A1150-F015-50	120	2.3	1.6	
	STF120-3AA-A1150-F015-50	120	3.0	1.3	
	STF350-3.5AA-A1150-F015-50	350	3.5	2.7	

*Other lead wire length can be supplied on request

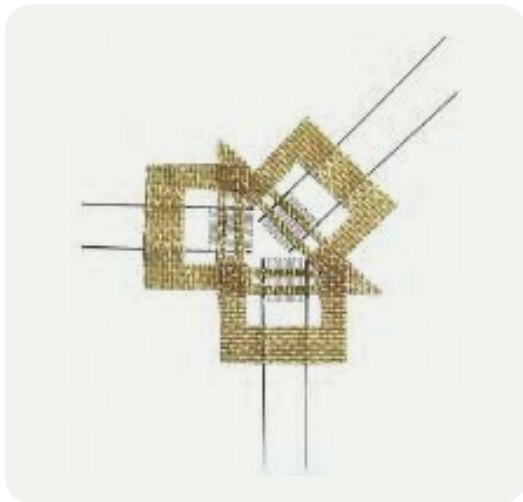

Wire rosettes

Wire strain gages rosettes can be made with two (BA configuration) or three (CA configuration) sensitive grids.

BA rosettes consist of two independent sensitive grids, oriented in different ways such as: V-type (0°-60° or 0°-45°) and L-type (0°-90°).

CA type rosettes consist of three independent sensitive grids, oriented at 0°-45°-90° or 0°-60°-120° and are intended for determination of complexly oriented deformations.

EA type rosettes consist of five independent sensitive grids, well known also as chains of strain gages and are intended for determining the most deformed point.

Gages are to be installed on the surface of the test object using ceramic cement adhesive or alumina flame spray method.

Gages are provided on the temporary fiberglass-reinforced PTFE carrier, which is subject to removal during installation of the strain gage.

Specifications

Nominal parameters	Value
Sensitive grid material	FeCrAl, NiCr or PtW
Possible number of sensitive elements	2 or 3
Nominal strain gage base length, mm	3-3.5
Resistance, Ohm	120-350
Resistance deviation in batch, not more than	±3%
Lead wire material	FeCrAl, NiCr or platinum-based alloy
Lead wire diameter, mm	0.07-0.15
Lead wire type	Ribbon or round
Lead wire length, mm	50-300
Temporary carrier	Fiberglass-reinforced PTFE
Types of BA configuration wire rosettes	T-type, L-type and V-type
Types of CA configuration wire rosettes	0°-45°-90° or 0°-60°-120°
Types of EA configuration wire rosettes	Chains of strain gages
Fatigue life at ±650 ppm at 20°C, cycles	10 ⁶
Bonding Methods	Ceramic Cement or Alumina flame spray
Type of measurements	Static and dynamic



Standard configurations

Strain gage configuration	Designation	Nominal resistance, Ohm	Nominal base length, mm	Nominal grid width, mm	Lead wires length, mm
	STN350-3.5CA-A900-N015-50	350	3.4	2.6	50...300
	STF350-3.5CA-A1150-F015-50	350	3.5	2.7	
	STP120-3CA-A1150-P007-45	120	2.95	1.6	
	STN350-3.5CA-B900-N015-50	350	3.4	2.6	
	STF350-3.5CA-B1150-F015-50	350	3.5	2.7	
	STP120-3CA-B1150-P007-45	120	2.95	1.6	
	STN350-3.5CB-A900-N015-50	350	3.4	2.6	
	STF350-3.5CB-A1150-F015-50	350	3.5	2.7	
	STP120-3CB-A1150-P007-45	120	2.95	1.6	
	STN350-3.5EA-A900-N015-50	350	3.4	2.6	
	STF350-3.5EA-A1150-F015-50	350	3.5	2.7	
	STP120-3EA-A1150-P007-45	120	2.95	1.6	
	STN350-3.5BB-A900-N015-50	350	3.4	2.6	
	STF350-3.5 BB-A1150-F015-50	350	3.5	2.7	
	STP120-3 BB-A1150-P007-45	120	2.95	1.6	
	STN350-3.5BC-A900-N015-50	350	3.4	2.6	
	STF350-3.5 BC-A1150-F015-50	350	3.5	2.7	
	STP120-3 BC-A1150-P007-45	120	2.95	1.6	

Note

According to customer requirements, can be designed special configuration and size. All high temperature wire strain gages can be customized.

HPM

03



Foil strain gages



High-temperature foil strain gages

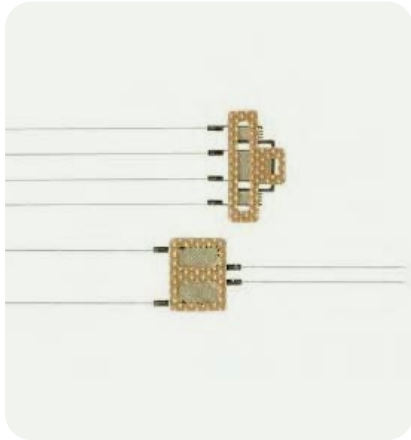

TG series foil strain gages

TG series strain gages are produced from iron-chromium-aluminum (Fe-Cr-Al) alloy foil by wet etching process. They are intended for the measurements of static deformations and mechanical tensions in the 269...+800°C temperature range. Installation of the gages on the test object is done with a special high-temperature ceramic glue, e.g., CC-02.

While using TG series strain gages, temperature compensation is done by connecting the same strain gage in the adjacent branch of the measuring circuit. This allows to reach higher precision of the measurement.

Designation system

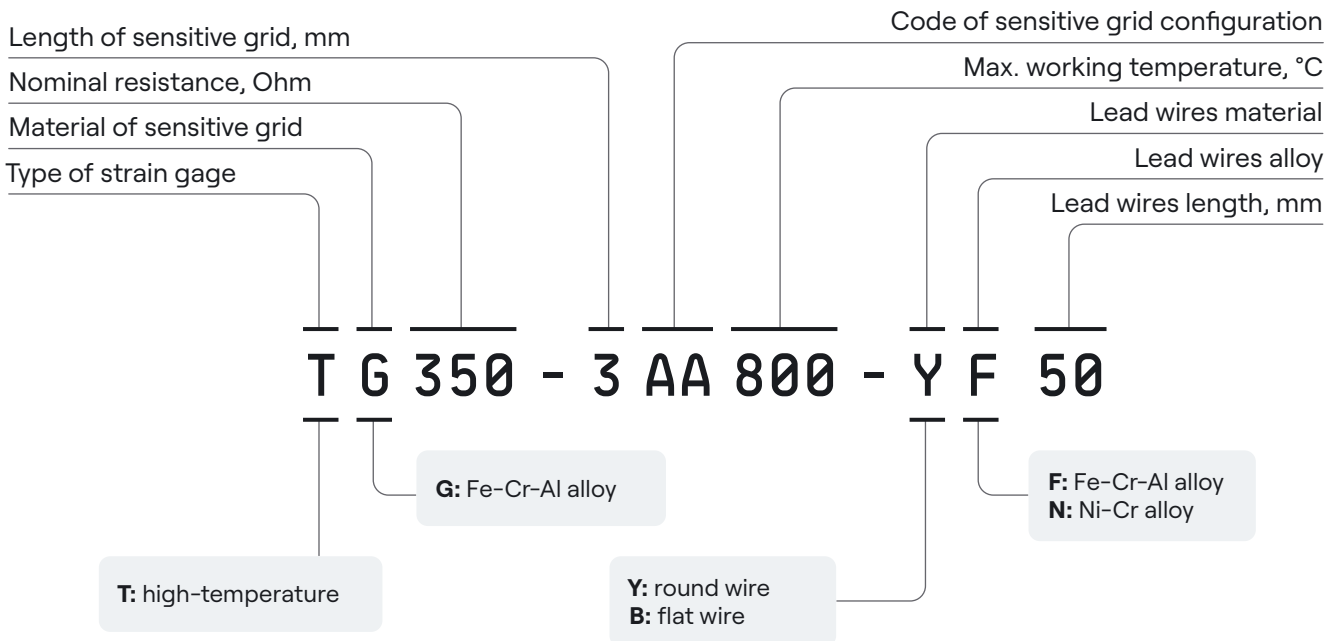





TG series strain gages are shipped on the temporary fiberglass-reinforced PTFE backing, which helps to keep the shape of the gage during the installation process. After installation the temporary backing is removed.

Each lead wire has electric resistance of 10 Ohms. TG gage resistance should be measured at the center of the lead wires (25 mm from the loose end), then the measured resistance will be $350 \pm 0.3\%$ Ohm.

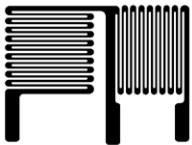
Standard configurations

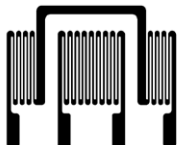
Strain gage configuration	Designation	Nominal resistance, Ohm	Nominal base length, mm	Nominal gage width, mm	Lead wires length, mm
	TG350-5AA800-YF50	$350 \pm 0.3\%$	5	3.66	
	TG350-3AA800-YF50	$350 \pm 0.3\%$	3	5.11	
	TG120-5AA800-YF50	$120 \pm 0.3\%$	5	2.47	
	TG120-3AA800-YF50	$120 \pm 0.3\%$	3	2	
	TG350-3BB800-YF50	$350 \pm 0.3\%$	3	7.72	50...300*
	TG350-3HA800-YF50	$350 \pm 0.3\%$	3	5.53	
	TG350-3FB800-YF50	$350 \pm 0.3\%$	3	8	

Note

According to customer requirements, can be designed special configuration and size. All high temperature foil strain gages can be customized.



Mid-temperature BQ250 and BAB350 foil strain gages

General information

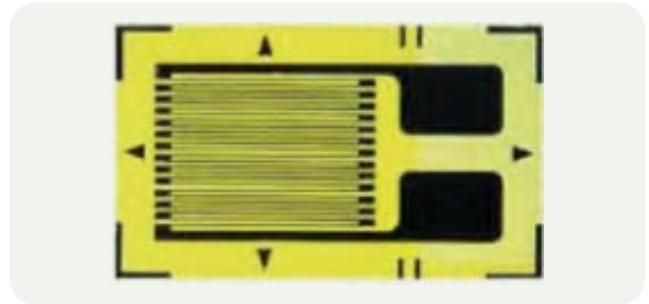
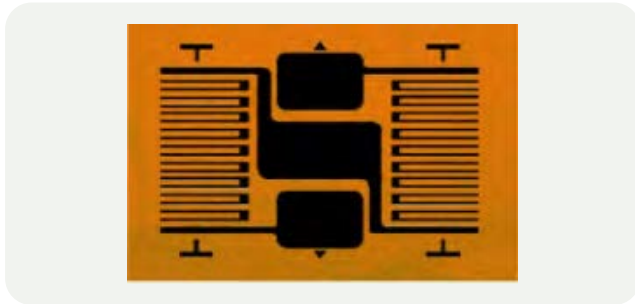

BQ250 is a Karma alloy foil based series strain gage, supplied on a special phenolic-soaked paper backing. This backing ensures extended temperature range of $-269...+250^{\circ}\text{C}$ along with perfect adhesion properties. Also, due to the flexible backing, BQ250 series gages can be installed on surfaces with complex geometries (small radius curves, thin tubes, etc.). After installation, a proper humidity and moisture protection must be ensured for this series gages, e.g., using our special protective glue.

BAB350 series foil strain gages are produced from Karma alloy on a fiberglass-reinforced polyimide backing. In comparison with conventional Constantan alloy, Karma alloy has almost linear thermal output in $-20...+250^{\circ}\text{C}$ temperature range. Special backing provides excellent isolating qualities at $-269...+250^{\circ}\text{C}$ long-term and up to $+350^{\circ}\text{C}$ for short-term. These strain gages are supplied fully covered with a protective polyimide film, and with high-temperature lead wires.

Designation system

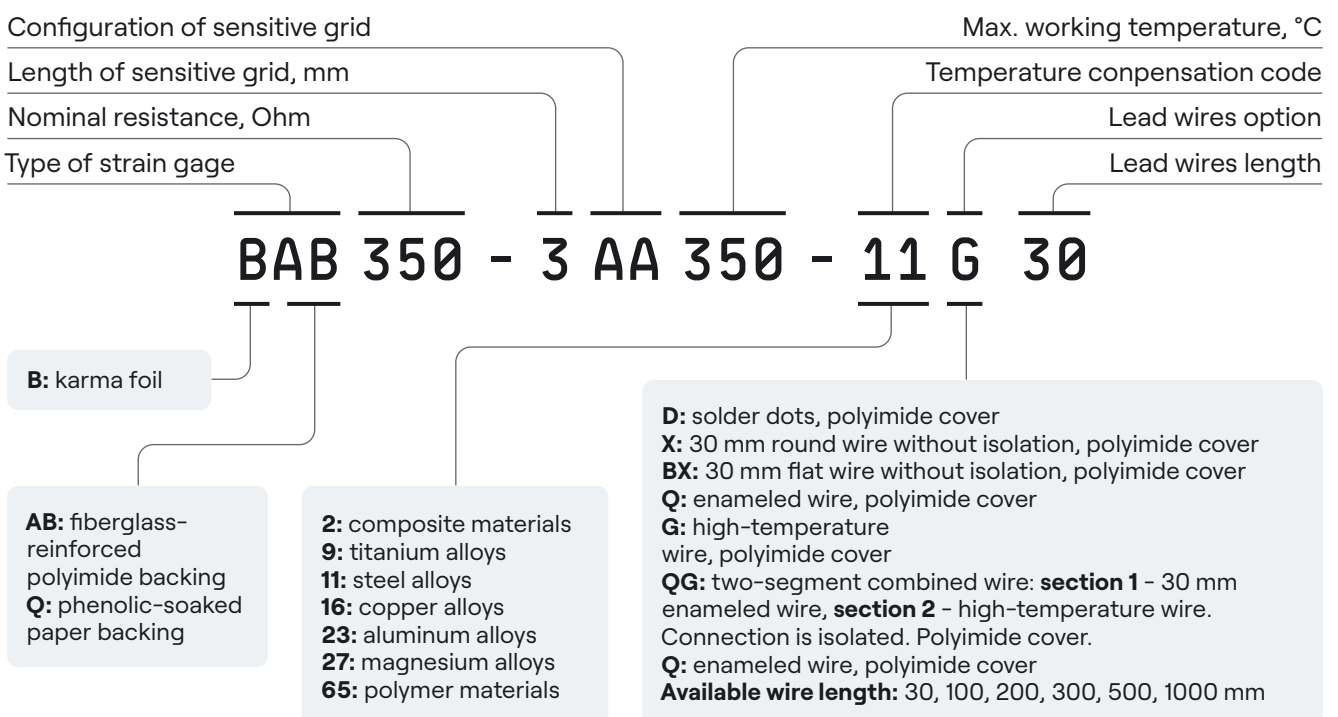



Products specifications

Typical specifications	BQ250	BAB350
Backing material	Phenolic-soaked paper	Glass-fibre-reinforced
Grid materials	Karma	Karma
Typical resistance, Ohm	120, 200, 350, 400, 700	120, 350, 250, 1000, 2000
Gage factor	2.00 ~ 2.20	1.86~1.98
Gage factor deviation in batch	≤±1%	≤±1%
Strain limit	2%	2%
Operation temperature range, °C	-269...+250	-269...+350
STC codes	2, 9, 11, 16, 23, 27, 65	9, 11, 16, 23, 27







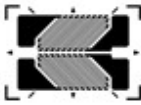
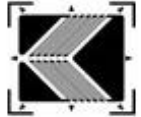

Standard configurations

Product form	Product Model	Sensitive grid size, L×W mm / diameter, mm	Backing size, L×W mm / diameter, mm
	BAB120-2AA350(**)	2.1×2.3	5.8×3.8
	BAB120-3AA350(**)	2.8×2.0	6.4×3.5
	BAB120-4AA350(**)	3.9×2.7	8.0×4.0
	BAB120-10AA350(**)	10.0×3.0	15.0×5.0
	BAB350-1AA350(**)	1.0×3.1	4.5×4.2
	BAB350-2AA350(**)	1.9×2.8	5.7×4.0
	BAB350-3AA350(**)	3.1×2.6	7.0×3.8
	BAB350-4AA350(**)	4.0×3.7	8.0×4.9
	BAB350-5AA350(**)	5.0×4.1	9.4×5.7
	BAB1000-3AA350(**)	3.2×3.2	7.4×4.5
	BAB2000-4AA350(**)	4.0×4.4	8.6×6.0
	BQ120-2AA(**)	2.0×1.7	5.4×3.2
	BQ120-3AA(**)	2.8×2.0	6.4×3.5
	BQ120-4AA(**)	4.2×1.9	8.2×3.6
	BQ120-5AA(**)	5.0×2.0	10.1×4.0
	BQ120-6AA(**)	5.9×2.7	9.8×4.3
	BQ120-8AA(**)	7.8×2.6	12.2×4.3
	BQ120-10AA(**)	9.8×3.0	15.0×5.0
	BQ200-3AA(**)	3.0×2.3	8.3×4.7
	BQ200-5AA(**)	5.0×2.2	11.8×5.9
	BQ200-10AA(**)	10.0×3.4	18.5×7.4
	BQ350-1.5AA(**)	1.5×4.0	4.9×4.8
	BQ400-5AA(**)	5.0×2.7	11.8×5.9
	BQ700-5AA(**)	5.0×3.9	9.0×5.6

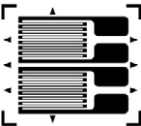

Product form	Product Model	Sensitive grid size, L×W mm / diameter, mm	Backing size, L×W mm / diameter, mm
	BQ120-20AA(**)	20.0×3.0	26.8×5.9
	BQ120-30AA(**)	30.0×2.3	36.0×5.7
	BQ120-40AA(**)	41.0×2.5	51.0×7.0
	BQ120-60AA(**)	57.0×2.2	67.0×6.7
	BQ120-80AA(**)	80.0×2.5	90.0×7.0
	BQ120-100AA(**)	100.0×3.7	110.0×7.0
	BQ200-20AA(**)	20.0×2.7	29.5×4.7
	BQ200-05AA-A(**)	0.5×5.2	5.0×7.0
	BAB120-3BB350(**)	2.8×3.3	8.5×6.5
	BAB120-4BB350(**)	4.0×4.4	10.3×7.5
	BAB350-1BB350(**)	1.3×1.7	5.4 ×4.4
	BAB350-1.5BB350(**)	1.5×2.0	5.1×4.6
	BAB350-2BB350(**)	1.9×2.5	6.4×5.5
	BAB350-3BB350(**)	3.0×3.4	8.8×6.8
	BAB350-4BB350(**)	4.0×4.3	10.0×7.8
	BAB350-5BB350(**)	4.7×5.2	11.6×8.3
BQ120-2BB250(**)	2.0×2.4	7.2×5.6	
	BQ400-3BB-B(**)	3.0×3.4	14.3×7.3
	BQ120-1CA(**)	1.3×1.5	7.6×7.6
	BQ120-2CA(**)	2.0×1.5	9.3×9.3
	BQ120-3CA(**)	3.1×1.8	11.1×11.1
	BQ120-4CA(**)	3.7×1.6	11.4×11.4
	BQ120-6CA(**)	5.9×3.1	15.0×15.0
	BQ120-2BA(**)	2.1×1.5	9.3×9.3
	BQ120-3BA(**)	3.1×1.8	11.1×11.1
	BQ120-4BA(**)	3.8×1.7	11.7×11.7
	BQ120-6BA(**)	5.9×3.1	15.0×15.0
	BQ350-3BA(**)	3.2×2.8	11.0×11.0
	BQ120-2CC(**)	2.2×1.9	8.5×8.5
	BAB350-3HA-C350(**)	3.0×3.8	9.5×7.8

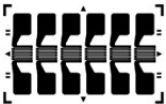

Product form	Product Model	Sensitive grid size, L×W mm / diameter, mm	Backing size, L×W mm / diameter, mm
	BAB350-3HA-A350(**)	3.0×4.4	9.4×6.5
	BAB350-4HA-A350(**)	4.0×3.6	8.8×7.8
	BAB1000-3HA-A350(**)	3.0×4.5	9.4×6.5
	BAB250-1HA-W350(**)	1.0×1.3	3.8×2.8
	BAB300-2HA-W350(**)	2.0×1.2	4.0×4.0
	BAB350-1HA-W350(**)	1.0×1.3	3.8×2.8
	BAB350-2HA-W350(**)	2.0×1.2	4.0×4.0
	BAB350-4HA-E350(**)	3.9×2.3	8.3×8.3
	BAB350-2FB350(**)	2.0×2.0	5.6×5.2
	BAB1000-6FB350(**)	6.0×2.4	9.5×6.8
	BAB350-(6-B10)KA350(**)	∅ 6.4	∅ 10.0
	BAB350-(10)KA350(**)	∅ 8.8	∅ 10.0
	BAB350-(13)KA350(**)	∅ 12.4	∅ 13.0
	BAB350-(15)KA350(**)	∅ 14.0	∅ 15.0
	BAB350-(20)KA350(**)	∅ 18.6	∅ 20.0
	BAB1000-(10)KA350(**)	∅ 9.0	∅ 10.0
	BAB1000-(20)KA350(**)	∅ 18.6	∅ 20.0
	BAB350-(10)KA-A350(**)	∅ 9.2	∅ 10.0
	BAB350-(20)KA-A350(**)	∅ 19.0	∅ 20.0
	BAB350-(6)KA-B350(**)	∅ 5.6	∅ 6.0
	BAB120-1GF350(**)	1.0×1.0	9.8×6.0
	BAB120-1FF350(**)	1.0×1.1	9.8×6.0
	BAB120-1BD350(**)	1.0×1.0	9.8×6.0

Note

(**) stands for the temperature compensation code. Please indicate the necessary one in your order.

HPM

04



Weldable strain gages



General information

The weldable strain gage is a special resistance strain gage that inherits the typical characteristics of a universal strain gage preinstalled on piece of foil, especially for metal structures, precision stress measurement and analysis.

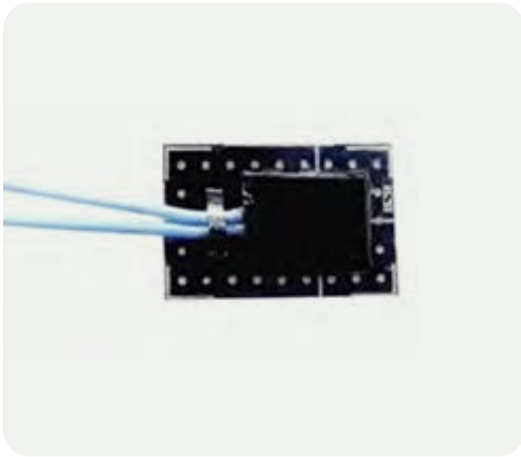

HKB series weldable strain gages for mid-temperature

HKB series strain gages are weldable strain gages with IP67 protection class. They are used in harsh conditions, when standard bonding of the gages is impossible due to high humidity, impossibility to clean the test object, etc. These strain gages are installed on the test object using dot spot welding machine. Operating temperatures range is -30...+250°C.

Designation system

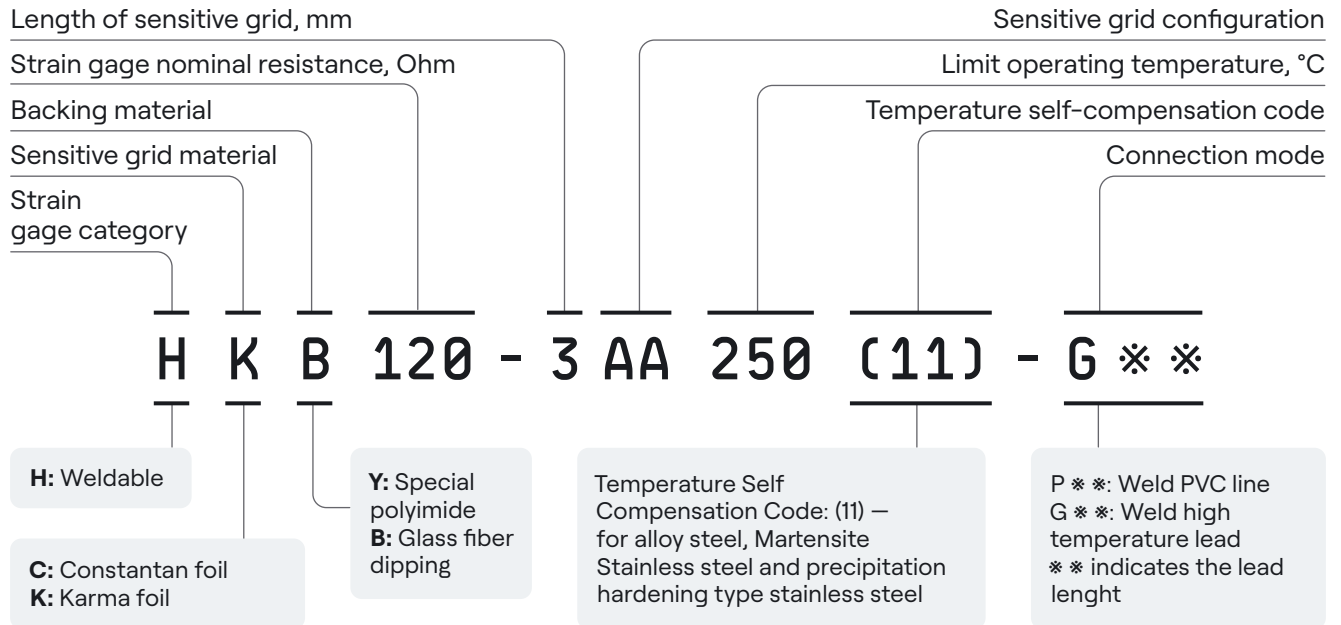



Specifications

Nominal parameters	Value
Sensitive grid material	Karma foil
Backing material	Glass fiber reinforced polyimide
Base body material	Stainless steel
Base body thickness (mm)	0.1
Typical resistance (Ohm)	120 - 350
Resistance tolerance	≤±0.1%
Typical sensitivity coefficient	1.70~2.1
Sensitivity coefficient dispersion	≤±2%
Use temperature range	-30°C ~+250°C
Strain limit	±3000μϵ
Protection mode	Silicone protection
Installation method	Spot welding installation

Installation method

Spot welding (e.g. using CDWT-6001 spot welding machine). Rough polishing of the installation surface is recommended if possible.

Standard configurations

Strain gage configuration	Designation	Nominal resistance, Ohm	Sensitive grid size Long (L) × width (W), mm	Backing size Long (L) × Width (W), mm	Lead wires length, mm
	HKB120-3AA (11)-G**	120 ± 0.1 %	6.4×3.5	14.6×8.9	
	HKB350-3AA (11)-G**	350 ± 0.1 %	7.0×3.8	14.6×8.9	
	HKB120-3CA-T(11)-G**	120 ± 0.1 %	11.7×8.5	15.5×14.9	50...300*
	HKB350-3BB-A (11)-G**	350 ± 0.1 %	8.5×6.5	13.7×13	



Precautions

1. Weldable strain gages should be stored in a dry, cool environment, to prevent the metal base body is oxidized.
2. In the installation of the weldable strain gage, must fully polish and remove the oxide, glue film, stains of the welding area, otherwise resulting in low welding strength or poor welding and other quality issues.
3. Before spot-welding the strain gage, please trial welding the test piece in order to find out the appropriate welding parameters to ensure the good quality for the official installation. (Welding trial piece is stainless steel piece with the same thickness as the weldable strain gage, 1 to 2 pieces will be supplied by the manufacturers freely.
4. After a while of the usage of the Spot-welding machine, the welding hand electrode will be oxidized, need to be re-polished by using sandpaper or rasp. Otherwise if continue to use the machine, there will be sparking on the welding electrode and metal base body (with strong light and large sound).
5. The installation of the weldable strain gage, please wear the protective glasses and protective gloves, so as not to harm the eyes and arms by the sparks.
6. When use spot-welding machine to install the strain gage, must ensure the reliable grounding, the surrounding environment has no splashing liquid, to eliminate the possible shock risk factors.

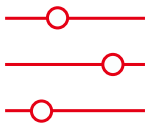

If you have special requirements or other requirements, please contact and communicate with us in time. The sensitive coefficient of the weldable strain gage is about 10% smaller compared to the bondable strain gage.



WTN series weldable strain gages for high-temperature

WTN series weldable high temperature strain gages are intended for measurements of deformations in the details of machinery and equipment under dynamic loads in 269...+900°C temperature range.

These gages are intended for installation in places where bonding with ceramic cements is not possible either due to complication in surface preparation (polishing, degreasing, etc.) or due to large dimensions of the test object (cannot be thermally treated for cement curing).

Construction-wise a WTN series strain gage is a STN series wire strain gage, installed on a small piece of thin metal foil with ceramic cement.

Sensitive grid of the gage is made of 15...30 um diameter nickel-chromium wire.

Backing material is an oxidation and corrosive resistant nickel-chromium superalloy. This material is selected to match the thermal expansion coefficient of the sensitive grid.

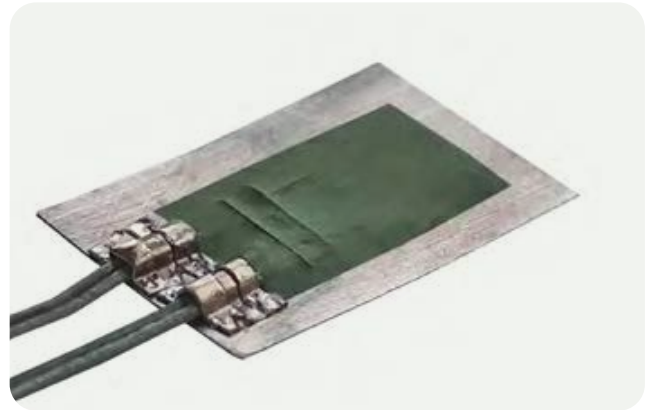

Sensitive grid is installed on the backing using high temperature ceramic cement, applicable for long-term operation at 900°C. Ceramic cement also acts as an insulator layer between backing and the grid. Cement layer is protected against humidity with an organosilicon varnish.

Lead wires are made in a 2-core of nickel, alumel or micable in silica braid sheath. Typical diameter of the cores is 0.3 mm, but can be changed on demand. Typical length of the lead wires is 100 mm

Designation system

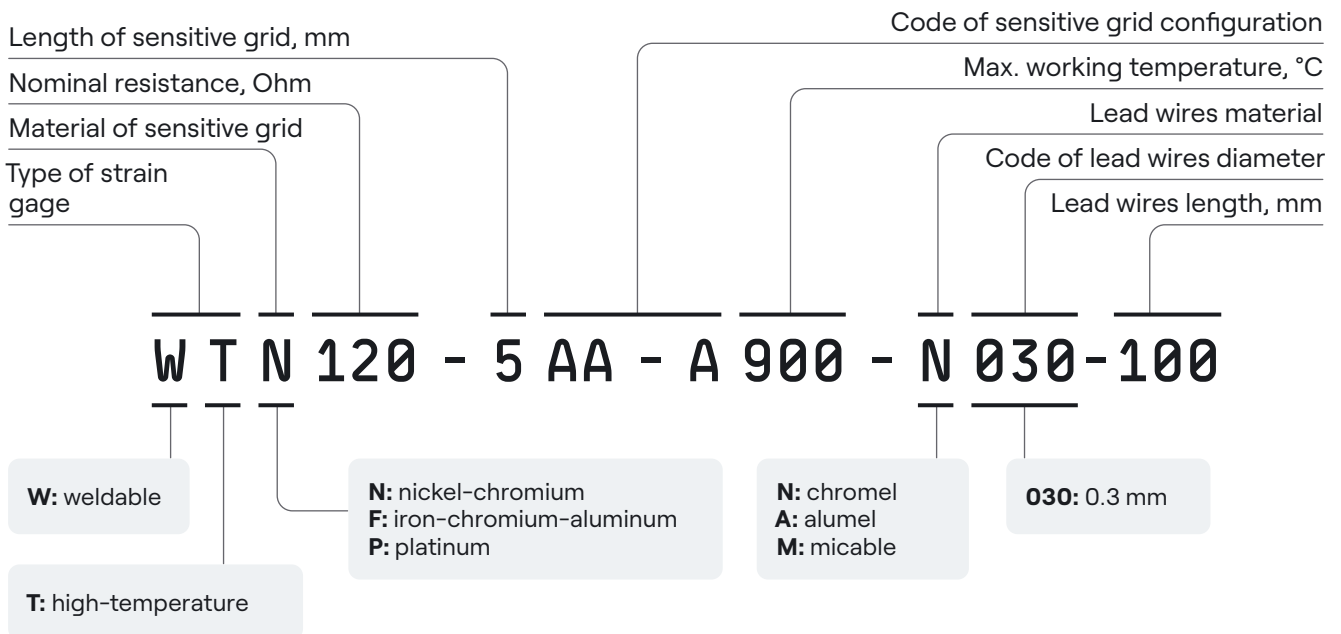



Schematic drawing

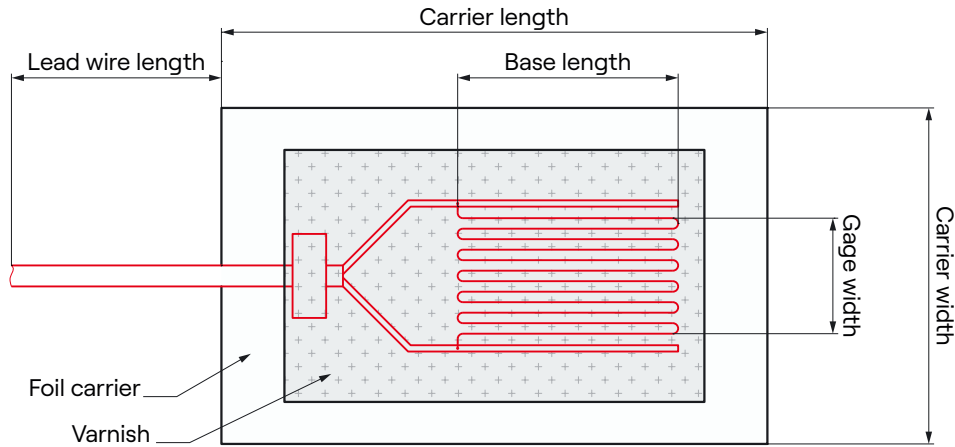

Standard configurations

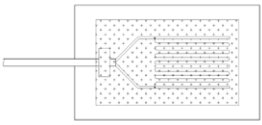
Strain gage configuration	Designation	Nominal resistance, Ohm	Nominal base length, mm	Nominal gage width, mm	Carrier length/width, mm	Lead wires length, mm
	WTN120-3.5AA-A900-C030-100	120 ± 3 %	3.5	2.0	13.0 × 8.0	100.0*
	WTN350-3.5AA-A900-C030-100	350 ± 3 %	3.5	2.6		

*Other lead wire length can be supplied on request

Installation method

Spot welding (e.g. using CDWT-6001 spot welding machine). Rough polishing of the installation surface is recommended if possible.

Packaging

Individual strain gages are supplied in plastic boxes. Each strain gage is labelled with the actual electric resistance values.

Groups of strain gages are packed in plastic boxes in max. amount of 10. Each group packing has a label with the main parameters of the gages, including resistance range of the gages group, gage factor, production date, etc.

Batches of strain gages are packed in plastic containers. Each batch container has a label with all main parameters of the gages, general description, batch number and production date.

Fatigue life

1·10⁵ at ±500 microstrain at 300°C.

Shelf life and storage conditions

6 months at +10 ~ +40°C, 50% RH max

HPM

05



HPM technology
for 400°C

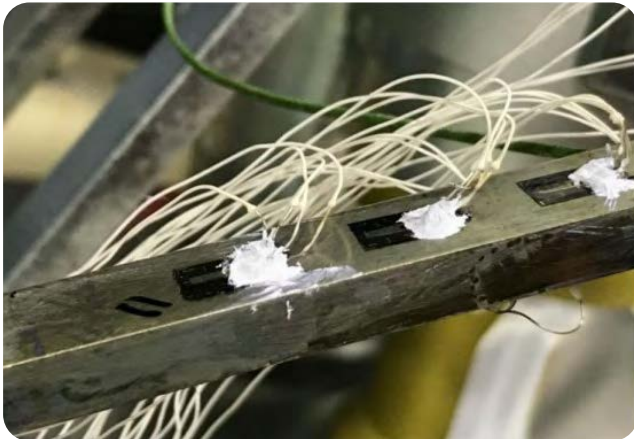

HPM technology for 400°C strain measurement

Special technology for measurements at working temperature range up to 400°C deg means that our engineers found best solution how to simplify strain gages application process for short time stress/tensile tests for instrumentation community.

Earlier such “mid temperatures” test at working temperature 250–400°C deg was required high temperature free filament wire strain gages, that complicates the process of measurements a lot as application process is quite difficult, takes a lot of time and require special equipment and skills.

So, we find the solution how engineers who are accustomed to using conventional foil strain gages for low temperatures, can work with simplified technology for the application of wire strain gages with UV light curing.

Our technology provides for customer

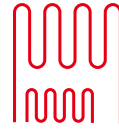

1. STN series wire strain gages or Special BAB250 series of strain gages (Karma alloy on fiberglass-reinforced polyimide baking) with special technology welded leads.



2. Special custom adhesive that cures with ultraviolet light.



3. Prewelded wires with any required length.



4. Special protective sealant to protect the most vulnerable area of the strain gage (where the wires are welded).



5. Instruction of strain gages application.



Lead time of providing such technology could be up to 8 weeks.

HPM

06



Adhesives



Adhesives

To ensure high accuracy and reliability of strain measurements, it is important to select the correct adhesive for bonding strain gages. Due to the limitations of the application conditions, there is currently no adhesive that is completely universal for all strain gages. Based on many years of manufacturing and testing experience, ZEMIC's and HPM's R&D department's has developed many special adhesives to meet all strain gage dissecting conditions. Adhesives suitable for the required operating conditions, measurement accuracy and other factors are available for customer selection.

This chapter provides all the characteristics of adhesives, including application features, operating temperature range, application and storage conditions. This will help you to select the right adhesive.



Note

Exceeding the shelf life of the adhesive deteriorates its properties. It is necessary to strictly adhere to the recommendations for the use and storage of the adhesive. Conventional universal adhesives are not suitable for bonding strain gages.

Selection guidelines

The selection of the suitable adhesive is generally based on three factors:



1. Strain gage operating temperature range and ambient humidity.

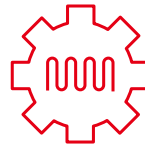

2. Possibility of heat treatment of the adhesive seam and possibility of long-term pressing of strain.



3. Required accuracy and duration of measurements.



Main adhesives characteristics

CC-02

Operating temperature range: Long-term usage up to 900°C. Short-term usage up to 950°C.

Content: One-component ceramic cement.

Method of application: 3 steps of heat treatment 95°C (45 min)-204 (30 min)-320 (50 min). With temperature increasing 2°C/min.

Shelf life: 6 months. **Packing:** 20 g.

H-600

Operating temperature range: Long-term usage: -269°C...+350°C. Short-term usage: -269°C...+370°C. Not suitable for waterproof strain gages.

Content: Two-component epoxy resin.

Method of application: Heat up to 135°C, clamped for 2 hours with 0.1...0.3 MPa force.

Usage up to 150 °C: Heat up to 165°C treat for 2 hours without clamped.

Usage up to 350°C: Heat up to 135°C clamped for 2 hours, with 0.1...0.3 MPa force.

Heat up to 175°C, treat for 2 hours without clamped.

Shelf life: before mixing: 8 months at 24°C; 12 months at 4°C. After mixing: 8 days at 24°C; 1 month at 4°C. **Packing:** 15 g/pack.

H-619

Operating temperature range: -269°C...+210°C.

Content: Two-component epoxy resin

Method of application: Heat up to 135°C, clamped for 2 hours, with 0.1...0.3 MPa.

Heat up to 165°C, treat for 2 hours without clamped

Shelf life: Before mixing. 6 months at 24°C. 12 months at 4°C After mixing. 8 days at 24°C, 1 months at 4°C. **Packing:** 15 g/pack.

H-621

Operating temperature range: -40°C...+250°C.

Content: One-component epoxy resin.

Method of application: Heat up to 180°C clamped for 3 hours, with 0.1...0.3 MPa force.

Shelf life: 220 days at 2...10°C. 240 days at 2...5°C. **Packing:** 15 g.

F-614

Operating temperature range: -269°C...+210°C.

Content: One-component based on phenolic and epoxy resins.

Method of application: Heat up to 100°C clamped for 1 hour, with 0.1...0.3 MPa force.

Heat up to 150°C, clamped for 2 hours, with 0.1...0.3 MPa force.

Heat up to 250°C for 4 hours without clamped.

Shelf life: 6 months at 4°C.

Packing: 10 g/pack.

F-601

Operating temperature range: -60°C...+250°C.

Content: One-component based on phenolic and epoxy resins.

Method of application: Heat up to 80°C, treat for 3 hours primer layer Paste and dry second layer at room temperature for 20 minutes.

Heat up to 100°C, clamped for 1 hour, with 0.1...0.3 MPa force.

Heat up to 150°C, clamped for 2 hours with 0.1...0.3 MPa force.

Heat up to 250°C, treat for 4 hours without clamped.

Shelf life: 8 months at 4°C. **Packing:** 10 g.



H-600

Main application

Strain gages bonding glue, recommended for high precision mass, load or force sensors, also for long-term or high-temperature (up to 370°C) tests.

Polymerization

Thermal treatment.

Content

Two-component, epoxy-based.

Key features

Wide temperature range, low viscosity, low hysteresis, low creep, good repeatability of the test data, simplicity of use.

Operation temperature range

Long-term usage:

-269°C...+350°C.

Short-term usage:

-269°C...+370°C.

Shelf life

Before mixing: 8 months at 24°C; 12 months at 4°C.

After mixing: 8 days at 24°C; 1 month at 4°C.

Mixing proportion

Component A : component B = 1:2.

Method of application

- Press or clamp with 0.1...0.3MPa force.
- Heat up to 135°C with the speed not more than 2°C per minute, treat for 2 hours.
- Cool down to room temperature and release the clamp.
- **For usage up to 150°C:** heat up to 165°C with the speed not more than 2°C per minute, treat for 2 hours.
- **For usage up to 370°C:** heat up to 175°C with the speed not more than 2°C per minute, treat for 2 hours.
- Cool down to room temperature.

Packing

2 bottles in pack: 1 bottle of component A (5g/bottle); 1 bottle of component B (10g/bottle).

6 bottles in pack: 3 bottles of component A (5g/bottle); 3 bottles of component B (10g/bottle).



H-611

Main application

For long-term field test.

Polymerization

At room temperature.

Content

Two-component; glycide

epoxy resin, bisphenol A epoxy resin, polysulfide rubber, modified amine hardener.

Key features

No solvent required, low creep, excellent isolation qualities.

Operation temperature range

-30°C...+80°C.

Shelf life

Before mixing: 10 months at 24°C.

After mixing: 30 minutes when used in winter; 10 minutes when used in summer.

Mixing proportion

Component A : component B = 4:1.

Method of application

- Press or clamp with 0.1...0.3MPa force.
- Hold 24 hours at 24°C.
- Release the clamp.

For accelerated curing:

- Heat up to 80°C with the speed not more than 2°C per minute, treat for 2 hours
- Cool down to room temperature and release the clamp.

Packing

8 bottles in pack: 4 bottles of component A (8g/bottle); 4 bottles of component B (2g/bottle).



H-613

Main application

Intended for high precision and long-term fatigue tests at elevated temperatures up to 150°C.

Content

Two-component; glycide epoxy resin, bisphenol A epoxy resin, modified amine hardener.

Key features

Low creep, excellent isolation qualities.

Polymerization

Press and room temperature curing.

Operation temperature range

-30°C...+150°C.

Shelf life

Before mixing: 10 months at 24°C.

After mixing: 20 minutes.

Mixing proportion

Component A : component B = 10:3.

Method of application

- Press or clamp with 0.1...0.3 MPa force.
- Hold 24 hours at 24°C.

- Release the clamp.
- Press or clamp with 0.1...0.3MPa force.
- Hold 24 hours at 24°C.
- Release the clamp.

For accelerated curing:

- Heat up to 80°C with the speed not more than 2°C per minute, treat for 3 hours
- Cool down to room temperature and release the clamp.

Packing

6 bottles/box: 3 bottles of A part (10g/ bottle); 3 bottles of B part (3g/ bottle).
2 bottles/box: 1 bottle of A part (10g/ bottle); 1 bottle of B part (3g/ bottle).



H-619

Main application

H-619 is a multi-purpose two-component epoxy based adhesive, designed for high precision gages and compensating resistors. It is highly recommended for high precision load cells (C4 class or higher) or when the accuracy of measurements is especially important.

Polymerization

Thermal treatment.

Content

Two-component, epoxy-based.

Key features

wide temperature range, low viscosity, low hysteresis, low creep, good repeatability of the test data, simplicity of use, short application cycle.

Operation temperature range

-269°C...+210°C.

Shelf life

Before mixing: 6 months at 24°C; 12 months at 4...8°C.

After mixing: 7...10 days at 20...25°C; 25 days at 4...8°C.

Mixing proportion

Component A :
component B = 1:1.

Bonding technology

- Press or clamp with 0.1...0.3MPa force.
- Heat up to 135°C with the speed not more than 2°C per minute, treat for 2 hours.
- Cool down to room temperature and release the clamp.
- Heat up to 165°C with the speed not more than 2°C per minute, treat for 2 hours.
- Cool down to room temperature and release the clamp.

Packing

1 kit (1 bottle of component A, 7.5 g; 1 bottle of component B, 7.5 g) or 3 kits (three bottles of each component). Volume of the bottles is enough for mixing both components in any of them.



H-621

Main application

H-621 is a single-component adhesive, based on modified epoxy resin. It is well suitable for strain gages with thin

backing and those that work in elevated humidity environment. Operating temperature range is -40...+250°C.

Polymerization

Thermal treatment.

Content

One-component, epoxy-based.

Key features

Strong adhesion, excellent isolation qualities, low viscosity.

Operation temperature range

-40°C...+250°C.

Shelf life

220 days at 2...10°C; 240 days at 2...5°C.

Bonding technology

- Press or clamp with 0.1...0.3MPa force.
- Heat up to 180°C with the speed not more than 2°C per minute, treat for 3 hours.
- Cool down to room temperature and release the clamp.

Packing

6 bottles box: 15g/bottle.

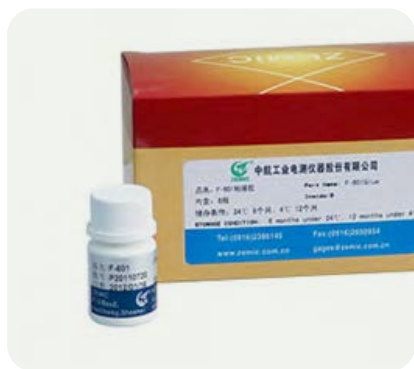

F-601

Main application

Elevated and high-temperature tests.

Polymerization

Thermal treatment.

Content

One-component, epoxy- and phenolic-based.

Key features

Strong adhesion, excellent isolation qualities, low creep, stable parameters in elevated and high-temperature range.

Operation temperature range

60°C...+250°C.

Shelf life

6 months at 4°C.

Method of application

- Paste the primer layer, heat up to 80°C with the speed not more than 2°C per minute, treat for 3 hours.
- Paste the second layer of the glue and air dry for 20 minutes.

- Paste the strain gage and press or clamp with 0.1...0.3MPa force.
- Heat up to 100°C with the speed not more than 2°C per minute, treat for 1 hour.
- Heat up to 150°C with the speed not more than 2°C per minute, treat for 2 hours.
- Cool down to room temperature and release the clamp.
- Heat up to 250°C with the speed not more than 2°C per minute, treat for 4 hours.
- Cool down to room temperature.



F-614

Main application

High-temperature and high humidity (up to 60%) tests.

Polymerization

Thermal treatment.

Content

One-component, epoxy- and phenolic-based.

Key features

Strong adhesion, excellent isolation qualities, good stability and repeatability, wide operation temperature range and good repeatability of the test data.

Operation temperature range

-60°C...+250°C.

Shelf life

6 months at 4°C.

Method of application

- Press or clamp with 0.1...0.3MPa force.
- Heat up to 100°C with the speed not more than 2°C per minute, treat for 1 hour.
- Cool down to room temperature and release the clamp.

- **For usage up to 150°C:** heat up to 165°C with the speed not more than 2°C per minute, treat for 2 hours.
- **For usage up to 370°C:** heat up to 175°C with the speed not more than 2°C per minute, treat for 2 hours.
- Cool down to room temperature.
- Heat up to 250°C with the speed not more than 2°C per minute, treat for 4 hours.
- Cool down to room temperature.

Packing

8 bottles box: 10g/bottle.



CC-02 High-temperature cement glue



General information

High-temperature cement is a green color pastelike inorganic ceramic adhesive, having good adhesion and excellent endurance after polymerization. Green pigment has been added to the composition which allows visual determination of the optimum thickness of the cement layer.. Max. operating temperature of this adhesive is 900°C (short term – up to 950°C).

Main Application

For high temperature strain guges bonding.



Surface preparation requirements:

- To achieve superior bonding strength, a mechanical treatment of the installation is required. Sandblasting is the best way to prepare the surface, but sanding with sandpaper #80...120 grit also produces good results. Sanding may not be acceptable for turbine blades and other components working under high mechanical tension.
- Polished area must be cleaned out with acetone several times to guarantee that the surface is absolutely clean and greaseless. After this, it is prohibited to touch the treated surface.
- To improve cement adhesion, the surface should be treated with SC-3 Conditioner and NC-3 Neutralizer.

Storage conditions

At normal conditions in the original packing, shelf life of the cement glue is 6 months. After opening of the bottle, shelf life is 1 month.

Precautions and recommendations

- Please avoid direct contact of the cement glue with exposed skin, mucous membranes or respiratory system.
- After long-term storage of the cement glue, before usage and during usage it is needed to mix the bottle content thoroughly until the solution becomes homogenous.
- To prevent evaporation of the solvent, comprised in the cement glue, the bottle with the glue must be tightly closed during all time when it is not used.
- If the cement glue dried out during storage, it is possible to regulate its viscosity by adding deionized water. Please consider that doing so can influence the glue polymerization process.

Packing

1 bottle: 20g/bot.

Shelf life

6 months after production; 1 month after opening.



Surface preparation agents

Surface Conditioner SC N°3 and Neutralizer NC N°3 are special solutions designed for finishing surface cleaning from contaminants not removed by wiping the surface with alcohol or other solvents and for the formation of a film on the surface of the workpiece to ensure maximum adhesion of ceramic cement and organic glues.

Surface Conditioner SC N°3

Main application

Solution for cleaning the surface of impurities not removed by wiping with alcohol or other solvents and preparing the surface for the application of ceramic cement.

Key features

Provides good wetting of the surface and forms a film on the surface of the workpiece, which increases the adhesion of ceramic cement.

Shelf life

12 months.

Method of application

Wipe the surface with a lint-free cloth or cotton bud moistened with the solution, if necessary, repeat several times until wetting of the surface with the solution is achieved. Then wipe off with a clean, dry, lint-free cloth.

Packing

20 or 30 ml glass bottle.

Neutralizer NC N°3

Main application

Solution to neutralize residual of SC N°3 conditioner before applying ceramic cement.

Key features

Neutralizes residual of SC N°3 conditioner, provides final cleaning of the surface before ceramic cement application.

Shelf life

6 months.

Method of application

Wipe the surface with a lint-free cloth or cotton bud moistened with the solution, wipe with a dry cloth, air dry.

Packing

20 or 30 ml glass bottle.

HPM

07



**Additional tools
and materials**



Consumables and installation kits

For our customers, we also provide sets of tools and consumables that may be useful when working with strain gages.



Set of consumables may include

1. Colored heat shrink tube for marking of the wires — used for marking of leads of strain gages. (Optional: 40 pcs. and 64 pcs. Diameter from 1 to 1.5 mm. Shrinkage when heated about 40%).
2. Transparent heat shrink tube to protect markings from oil or kerosene (diameter 2-3 mm).
3. Glass stocking (diameter of 1-5 mm).
4. Flat synthetic brush No. 1, 2, 3.
5. PTFE tape. Thickness 0.05 mm, width 30 mm (or a multiple of 60 or 90 mm). Tape length — a multiple of 1 m.
6. Polyimide tape (Kapton). Width 30 mm, Roll length 33 m. Application temperature up to 300°C.
7. Heat resistant tape (PET). Width 30mm, Roll length 33 m, Application temperature up to 200°C.
8. Marker pen, thin (0.3 mm).
9. Round synthetic brush No. 1, 2, 3.

Note

The installation kits may differ from those shown in the picture due to customers' needs and requests.

Set of tools may include

1. Cutters, precision side cutters.
2. Pliers 2 pcs.
3. Medical scissors ~150 mm, manicure scissors.
4. Ruler.
5. Tweezers: 1) straight thin, 2) curved thin, 3) wide.
6. Awl.
7. Spatulas: 1) with straight ends 2) with a "spoon".
8. Modelling knife (scalpel) with oblique blade №11 + spare blades (10 pcs).
9. Surgical scalpel with interchangeable semi-circular blades #23 + spare blades (10 pcs.)
10. Needle file set.
11. Magnifying glass.
12. Flat and thin brushes 5 (10) pcs. each
13. Metal spring clamps (for the possibility of maintenance in the furnace) ~100, 150 mm.
14. Electronic scales 50g/0,001g.
15. Mechanical pencil 0,5 mm + rods.
16. Permanent marker 0.5 mm.



Thermal indication paint

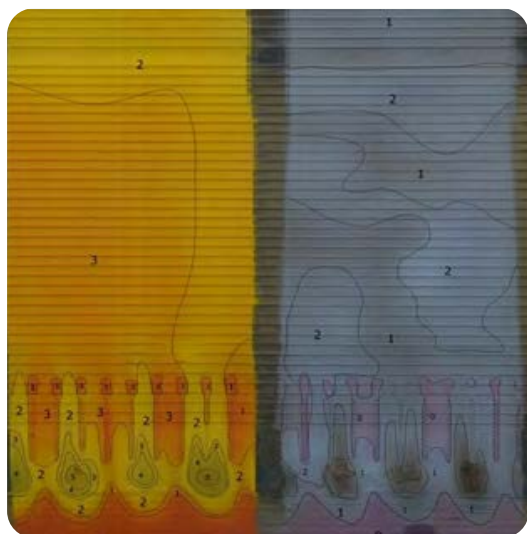

General information

TSP irreversible thermal indicator paint is used to control and measure the temperature of heated surfaces. It has up to 7 temperature transition points, is easy to use and covers a wide temperature range of experiments – from 160°C to 1150°C (refer to the table below to see the relevant ranges for different paint models). The paint is based on temperature sensitive pigments such as cadmium sulfide.

Properties

Number of color transition points: 2 to 7.

Temperature ranges: 160 to 1150°C.

Application method

Brush or sprayer.

Curing method:

30 minutes at 220°C or 24 hours at room temperature. Some paints can only be dried only at room temperature.

Packing

500 ml bottle.

Shelf life

24 months.

Standard configurations

Item	Bottle volume, L	Temperature range, °C	Number of color transition points
Thermal indication Paint TSP-M02	0.5	490, 615, 630, 827, 865, 905, 925	7
Thermal indication Paint TSP-M03	0.5	160, 193, 245, 302, 346, 385	6
Thermal indication Paint TSP-M04	0.5	470, 635, 685, 835, 855	5
Thermal indication Paint TSP-M05	0.5	710, 850, 955	3
Thermal indication Paint TSP-M07	0.5	935, 1025, 1075, 1150, 1165	5
Thermal indication Paint TSP-M10	0.5	490, 615, 630, 757, 940, 960	6
Thermal indication Paint TSP-M13	0.5	100, 160	2
Thermal indication Paint TSP-M14	0.5	110, 148	2



Thermocouple cable HRTW-CA

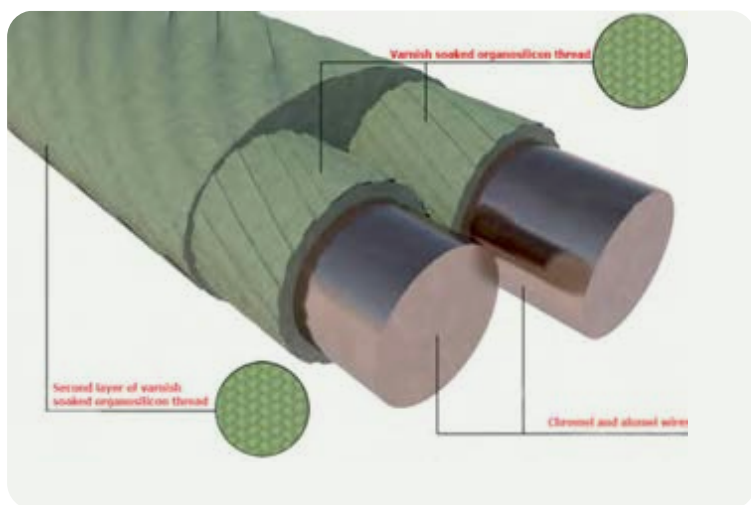

Cable decoding HRTW-CA

- H** – Heat
- R** – Resistant
- T** – Thermocouple
- W** – Wire
- CA** – Chromel – alumel
- CC** – Chromel-copel

General information

Thermoelectrode heat-resistant wire HRTW-CA designed for use as thermoelectrodes/extension wires for thermoelectric convertors (thermocouples). It can be used in high temperature areas with fixed mounting and no mechanical load on the insulation.

The wire is designed for operation at ambient temperature from -60°C to $+1200^{\circ}\text{C}$ and maximum permissible humidity up to 80% at temperatures up to $+35^{\circ}\text{C}$.

After heating to $+450^{\circ}\text{C}$, it is not allowed to subject the wire insulation to mechanical stress and kinks. The wire is non-flammable.

The compensating wires are included in the thermocouple circuit in compliance with the polarity sign.

Cable design elements

Two-core thermocouple heat-resistant wires with conductive cores made of a pair of alloys: chromel-copel and chromel-alumel, with varnish soaked organosilicon thread.

Purpose of HRTW-CA

They are used as thermocouples for fixed mounting in the absence of mechanical stress on the insulation during operation.

Working temperature from -60°C to $+900^{\circ}\text{C}$ (or shortly up to 1200°C).



HPM

08



Special
equipment





Temperature regulated curing furnace TRCF



Furnace for heat treatment of parts during strain gages bonding, as well as other heat treatment works.

The furnace has a temperature controller to regulate the temperature in the furnace chamber in accordance with the heat treatment programs for various adhesives and cements used in strain measurement of parts and assemblies.

The use of preset programs ensures that the entire heat treatment cycle is carried out in automatic mode and eliminates possible errors associated with incorrectly setting the temperature and/or the time of temperature set-

up or holding on the "shelf" by the user, and also frees the user from the need to reconfigure the controller to proceed to the next heat treatment step.

Additionally, the furnace, when executing the program, registers the values of the actual and calculated temperature in accordance with the heat treatment program being executed with a period of 1 to 5 minutes, which makes it possible to check the correctness of the choice and execution of the program after the end of the heat treatment.



Main characteristics of the TRCF-0500-060606

Example as most part of the parameters can be changed according to the customer's requirement*

Parameter name	Meaning
Working temperature range, °C	0°C – +50°C
Temperature control range, °C	0°C – +500°C
Temperature sensor type	Thermocouple chromel-alumel (type K)
Number of heat treatment programs	20
Programed for heat treatment of materials	ZEMIC H-600 and HPM CC-02
Temperature measurement error	Not more than $\pm(2^{\circ}\text{C}+1\%)$.
Overheat after temperature rise	Not more than 3°C (1°C typ).
Temperature fluctuations in the furnace chamber during the temperature maintenance phase	Not more than $\pm 2^{\circ}\text{C}$ (0.5°C typ).
Number of recorder entries	30 program runs
Power supply	Mains 220V \pm 10%, 50Hz.
Power consumption, W	Not more than 6000
Furnace chamber dimensions, mm	600 × 600 × 600
Guarantee period	1 year
Support	Technical support regarding usage and setting of treatment programs during first 3 months.

An example of a heat treatment program for ceramic cement, consisting of three steps





CDWT-6001 capacitive discharge welding tool

General information

Portable autonomous capacitive discharge welding tool is intended for the following tasks:

- Mounting of weldable strain gages with metal foil carrier up to 0.2 mm thick on metal details and assembly parts.
- Leading of elongation wires along details and assembly units, when such wires are fixed on the surface with 0.05 to 0.2 mm thick metal band stripes.
- Protection of the wires with full covers made of 0.05 to 0.2 mm thick metal foil, welded to the surface of details and assembly units.
- Welding of elongation wires to the lead wires of strain gages.
- Welding of thermocouples to details and assembly units; creation of inertia-free thermocouples.
- Other works requiring welding of thin-sheet metal material (foil) up to 0.2 mm thick to details and assembly units.

The tool can be used for welding of details from carbon steel, stainless steel, heat-resistant steel, heat-resistant alloys; titanium, nickel, nickel-chromium, and nickelchromium-aluminum alloys.

Product specifications

Built-in accumulator battery charging port: USB type C.

Built-in accumulator battery charging current: 1 A.

Control block dimensions: 156x180x52 mm

Control block weight: 1.3 kg

Length of ground clamp cable: 0.7 m

Length of welding gun cable: 1 m.

Battery charge is sufficient for at least 5000 welding points when working with 0.1 mm foil.



Capacitor battery recharge time after performing welding is:

- At power levels 0 to 7 – not more than 1 s;
- At power levels 8 and 9 – not more than 1.5 s.

Set of supply

Control unit – 1 pc, cable with ground clamp – 1 pc, cable with welding gun – 1 pc, charger – 1 pc, USB type C cable – 1 pc, product datasheet – 1 pc.



Tool for reproducing of deformations at high temperatures HTDR-1001

General information

The HTDR-1001 device for reproducing of deformations at high temperatures (hereinafter - Device) is intended for determination of parameters of strain gages such as: gage factor, creep and mechanical hysteresis in the temperature range from 20 to 1000°C.

Structure and parameters of the Device

The principle of operation is based on the deformation of a beam of constant cross-section (calibration beam) by the scheme of pure bending. Depending on the deflection of the beam, the relative deformation of the lower and upper surfaces of the beam is being determined.

The Device consists of a loading device, graduation beam, beam heating system, strain calibration device and deflection meter. The loading device consists of a frame, a fixed traverse fastened to the frame, and a movable traverse. Each traverse is equipped with rollers, between which a calibration beam is installed

As the movable traverse moves upwards, the upper fibers of the calibration beam are compressed, while the lower ones are stretched. Deformation of the beam is set using the deflection meter indicator installed on the beam surface.

TP-002T strain measuring device is used for multipoint measurements of static signals of strain gages (relative change in resistance of strain gages) and conversion of an analog signal into a digital one.



The calibration beam is made of a material that has a high limit of proportionality both at room and at elevated temperatures. When the beam is heated by electric current, its temperature is controlled by a thermoelectric transducer. Loading of the graduation beam is done manually by rotating the wheel on the front side of the device.

Signal from the strain gages installed on the graduation beam is collected in automatic mode using "Workstation for strain gages test" software, installed on a standalone PC. The software allows to input data and perform control from the keyboard, collecting signals by a predefined algorithm, mathematical processing of the data, display of obtained results and communication with other external devices.



Metrological parameters

Parameter	Value
Relative deformation measuring range, ppm	From -3000 to -100 and from +100 to +3000
Limit of maximum deviation of relative deformation measurement, by subranges, ppm	-3000 to -500 and +500 to +3000 ppm $\pm[8+0.004\varepsilon+0.05\cdot T]^*$
	-499 to -100 and +100 to +499 ppm $\pm[8+0.004\varepsilon+0.007\cdot T]$
Temporal instability of deformation maintenance, ppm	50 to 80

* ε – result of measurement of the relative deformation, unsigned, ppm

T – deviation of the beam temperature from the normal temperature (20°C)

Technical parameters

Parameter	Value	
Nominal dimensions of graduation beam, LxWxH, mm	600x12x6	
Deflection meter base length, mm	200	
Nominal deflection of the beam at 200 mm base length, mm	5.0	
Operating temperature range of the beam, °C	+15 to +1000	
Overall dimensions of the device, LxWxH, mm	330x600x560	
Net weight, max., kg	30.0	
Power supply parameters	Nominal voltage, VAC	220
	Frequency, Hz	50
	Power consumption, max., kVA	3.0
Operating conditions	Environment temperature, °C	+15 to +35
	Relative humidity, %	50 to 80

Standard equipment set

Name	Qty, pcs.
1. Loading device	1
2. Graduation beam	1
3. NORGAU 042 measuring head	1
4. Beam heating control system	1
5. TP-002T Multipoint measurement strain measurement device	1
6. Measuring channels switching box	2
7. Passport of the HTDR-1001 device	1
8. Passport of the TP-002T strain measurement device	1
9. HTDR-1001 user's guide	1



Tuning fork calibration device TFGD-4001

General information

TFGD-4001 provides reproduction of a dynamic sinusoidal deformation of a certain value. T-GD-4001 designed for calibration of measuring channels of strain gages, used for testing of jet engines and gas turbines, directly on the test object, also, during all kinds of stand dynamic tests, as well as for checking the correctness of operation and correctness of calibration of strain gages previously performed by other methods (e.g. calculation).

Technical specifications of TFGD-4001

Amplitude of mechanical stress at the place of strain gage sticking: up to 12 kg/mm².

Accuracy of measured deformation: ±10 mil. ppm.

Number of connected tuning forks is defined by tuning fork design and their connection scheme.

Strain gage base length: 0.5~10 mm.

Supply voltage: 5V.

Protection against electric shock: III (extralow voltage power supply).

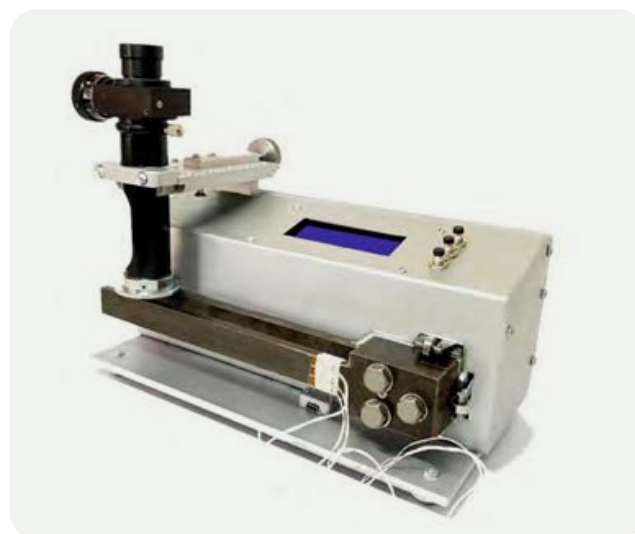

Power consumption, max.: 40 W max.

Operating conditions

Operation temperature: 18~45°C. Air humidity at 45°C not exceeding 90% RH.

Atmospheric pressure: not less than 720 mm Hg.

Depending on configuration, only MOM-20 optical microscope or HSV- 2000 laser vibrometer are subjects to metrological verification.

Standard equipment set

Type	Tabletop equipment
Operating temperature	18 to 45°C, RH 90% max, atmospheric pressure: 960 mbar min
Strain gage resistance range	Unlimited
Subject for periodic metrology control	Optical ocular or HSV- 2000 laser vibrometer
Number of connected strain gages	Determined by tuning fork design and strain gage connection scheme
Relative strain amplitude at the place of strain gage sticking	Up to 600 µm/m
Tuning fork material	Ferromagnetic steel
Width of tuning fork prong at strain gage resistor sticking point	20 mm
Natural frequency of oscillation of the tuning fork (typical)	128 Hz
Overall dimensions	280x140x220 mm
Weight	6.5 kg
Lifetime	Not less than 5 years

HPM

09



Services



Services

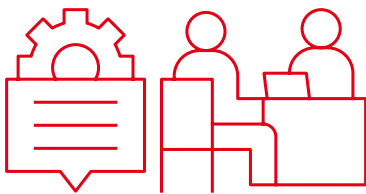

Consulting services

Thanks to outstanding experience in jet engine industry, our specialists can provide a literate consultation on your problematics:

- Installation and application recommendation
- Signal interpretation
- Design of auxiliary tools, clamps and loading mechanisms
- Fatigue test and high temperature test of strain gages (thermal output and load signal)

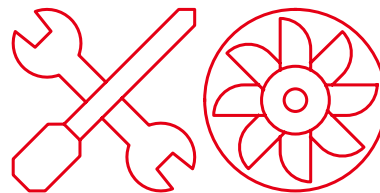
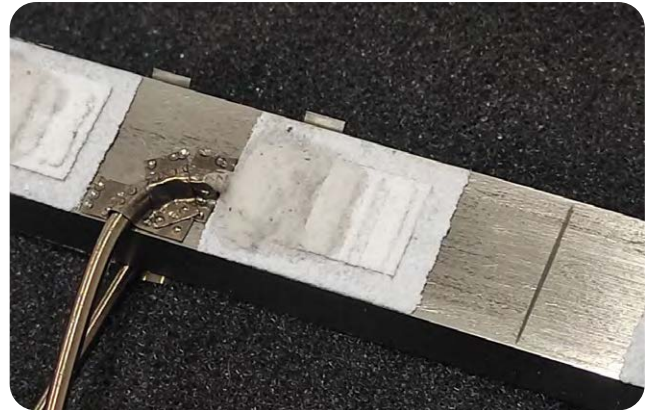

Installation services

We have all necessary equipment for pasting and thermal curing of all kinds of adhesives, including ceramic cements so our company can provide:

- Preparation of details (sandblasting, polishing)
- Installation of mid-range strain gages
- Installation of high temperature strain gages (Rokide and ceramic cement)
- Installation of thermocouples
- Pasting and decoding of thermal paint
- Soldering and welding of custom wires

HPM

10



Use cases



Use cases for High temperature strain gages

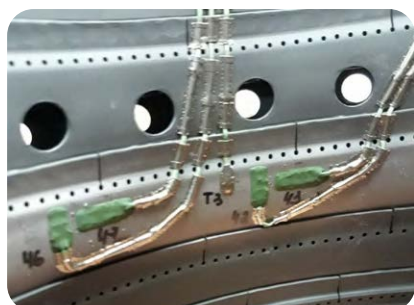

Remedial works due to cracks propagation on the walls of the combustion chamber. HPM nickel-chromium wire strain gages were installed using VPG HG-1 cement. Elongation cable routes are protected with spot-welded heat-resistant foil. In total, 60 strain gages were used for dynamic test of the combustion chamber.

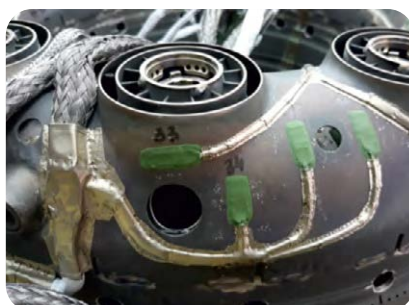

Test to determine the cause of burnouts around fuel injectors. 50 HPM nickel-chromium wire strain gages were installed using HPM CC-2 cement. Dynamic test was performed at normal engine working cycle for 5 hours. Strain test was preceded by TSP M02 thermal indicator paint application to clarify the temperature in different zones of the combustion chamber.



Certification works for the free turbine blades at 60,000 rpm. An 8-channel telemetry system was used, implementing 8 strain gages installed in critical points of the blades. Dynamic test is carried out throughout entire engine test program (around 6 hours).



Certification works for the turbine disk at 60 000 rpm. An 8-channel telemetry system was used, connecting 8 strain gages installed by 2-wire scheme on the turbine disc. Dynamic test is carried out throughout entire engine test program (around 6 hours).



Test to investigate the load on the free turbine shaft. 8 HPM nickel-chromium wire strain gages were installed on the shaft with CC-2 ceramic cement and connected through 8 channel telemetry system. Dynamic test was performed for 6 hours throughout all working cycles of the engine. This was the third part of certification tests, also comprising test of turbine disk and blades.



Strain test of fuel injectors installed in the combustion chamber flame tube. Two HPM 3mm nickel-chromium wire strain gages were installed on each igniter with ceramic cement VPG HG-1. Temperature was controlled using custom-made chromel-alumel thermocouple with core diameter of 0.3mm.

HPM

high precision measurements

© 2024 HPM. All rights reserved

DSPM Industria®
sensori & trasduttori

Via Paolo Uccello 4 - 20148 Milano
Tel +39 02 48 009 757 Fax +39 02 48 002 070
info@dspmindustria.it www.dspmindustria.it

